

XFP-BL23TG-10DC

10Gbps XFP BIDI Transceiver, Single Mode, 10km Reach
1270nm TX / 1330nm RX

Product Features

- Supports 9.953Gb/s to 11.1Gb/s bit rates
- Hot-pluggable XFP footprint, Built-in digital diagnos
- Maximum link length of 10km with SMF
- 1270nm DFB laser and PIN photodiode
- XFP MSA package with single LC connector
- No reference clock required
- Single +3.3V power supply
- Power dissipation <1.5W
- Compatible with RoHS
- Temperature range: 0 to +70°C



Applications

- SONET OC-192&SDH STM-64 at 9.953Gbps
- 10GBASE-LR/LW 10G Ethernet
- 10GE over G.709 at 11.09Gbps
- OC192 over FEC at 10.709Gbps
- Other optical links, up to 11.1Gbps

Description

The XFP module is compliant with the 10G Small Form-Factor Pluggable (XFP) Multi-Source Agreement (MSA), supporting data-rate of 9.953~11.1Gbps, and transmission distance up to 10km on SMF.

The transceiver module comprises a transmitter with 1270nm DFB laser and a receiver with a PIN photodiode. Transmitter and receiver are separate within a wide temperature range and offers optimum heat dissipation and excellent electromagnetic shielding thus enabling high port densities for 10 GbE systems.

Absolute Maximum Ratings

Parameter	Symbol	Min	Max	Unit
Supply Voltage	V _{cc}	-0.5	4.5	V
Storage Temperature	T _s	-40	+85	°C
Operating Humidity	-	5	85	%

Any stress beyond the maximum ratings can result in permanent damage. The device specifications are guaranteed only under the recommended operating conditions.

Recommended Operating Conditions

Parameter	Symbol	Min	Typical	Max	Unit
Operating Case Temperature	T _c	0		+70	°C
Power Supply Voltage @3.3V	V _{cc}	3.135	3.30	3.465	V
Power Supply Current	I _{cc}			500	mA
Data Rate		9.953		11.1	Gbps

Optical and Electrical Characteristics

Parameter	Symbol	Min	Typical	Max	Unit	Notes
Transmitter						
Centre Wavelength	λ_c	1260	1270	1280	nm	
Spectral Width (-20dB)	$\Delta\lambda$			1	nm	
Side-Mode Suppression Ratio	SMSR	30			dB	
Average Output Power	P _{out}	-5		-1	dBm	1
Extinction Ratio	ER	3.5			dB	
Data Input Swing Differential	V _{IN}	180		950	mV	2
Input Differential Impedance	Z _{IN}	90	100	110	Ω	
TX Disable	Disable	2.0		V _{cc}	V	
	Enable	0		0.8	V	
Receiver						
Centre Wavelength	λ_c	1320	1330	1340	nm	
Receiver Sensitivity				-14.5	dBm	3
Receiver Overload		0.5			dBm	3
LOS De-Assert	LOS _D			-15.5	dBm	

LOS Assert	LOS _A	-26			dBm	
LOS Hysteresis		0.5		4	dB	
Data Output Swing Differential	V _{out}	400	600	800	mV	2
LOS	High	2.0		V _{cc}	V	
	Low			0.8	V	

Notes:

1. The optical power is launched into SMF.
2. Internally AC-coupled.
3. Measured with a PRBS 2³¹-1 test pattern @9953Mbps, BER ≤1×10⁻¹².

Pin Descriptions

Pin	Logic	Symbol	Name/Description	Ref
1		GND	Module Ground	1
2		VEE5	Optional -5.2 Power Supply – Not required	
3	LVTTL-I	Mod-Dese I	Module De-select; When held low allows the module to, respond to 2-wire serial interface commands	
4	LVTTL-O	Interrupt	Interrupt (bar); Indicates presence of an important condition which can be read over the serial 2-wire interface	2
5	LVTTL-I	TX_DIS	Transmitter Disable; Transmitter laser source turned off	
6		VCC5	+5 Power Supply – Not required	
7		GND	Module Ground	1
8		VCC3	+3.3V Power Supply	
9		VCC3	+3.3V Power Supply	
10	LVTTL-I	SCL	Serial 2-wire interface clock	2
11	LVTTL-I/O	SDA	Serial 2-wire interface data line	2
12	LVTTL-O	Mod_Abs	Module Absent; Indicates module is not present. Grounded in the module.	2
13	LVTTL-O	Mod_NR	Module Not Ready;	2
14	LVTTL-O	RX_LOS	Receiver Loss of Signal indicator	2
15		GND	Module Ground	1
16		GND	Module Ground	1
17	CML-O	RD-	Receiver inverted data output	
18	CML-O	RD+	Receiver non-inverted data output	
19		GND	Module Ground	1
20		VCC2	+1.8V Power Supply – Not required	
21	LVTTL-I	P_Down/R ST	Power Down; When high, places the module in the low power stand-by mode and on the falling edge of P_Down initiates a module reset	
			Reset; The falling edge initiates a complete reset of the module including the 2-wire serial interface, equivalent to a power cycle.	

22		VCC2	+1.8V Power Supply – Not required	
23		GND	Module Ground	1
24	PECL-I	RefCLK+	Reference Clock non-inverted input, AC coupled on the host board – Not required	3
25	PECL-I	RefCLK-	Reference Clock inverted input, AC coupled on the host board – Not required	3
26		GND	Module Ground	1
27		GND	Module Ground	1
28	CML-I	TD-	Transmitter inverted data input	
29	CML-I	TD+	Transmitter non-inverted data input	
30		GND	Module Ground	1

Notes:

1. Module circuit ground is isolated from module chassis ground within the module.
2. Open collector, should be pulled up with 4.7k – 10k ohms on host board to a voltage between 3.15V and 3.6V.
3. A Reference Clock input is not required.

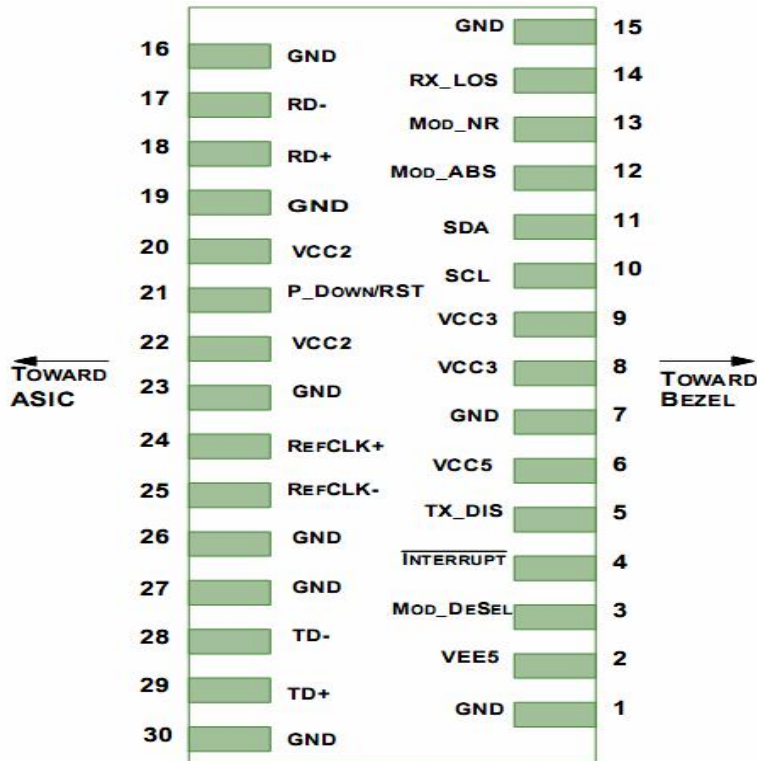

Management Interface

The transceivers provide serial ID memory contents and diagnostic information about the present operating conditions by the 2-wire serial interface (SCL, SDA).

The Module provides diagnostic information about the present operating conditions. The transceiver generates this diagnostic data by digitization of internal analog signals. Alarm/warning threshold data is written during device manufacture. Received power monitoring, transmitted power monitoring, bias current monitoring, supply voltage monitoring and temperature monitoring all are implemented.

The digital diagnostic memory map specific data field defines as following.

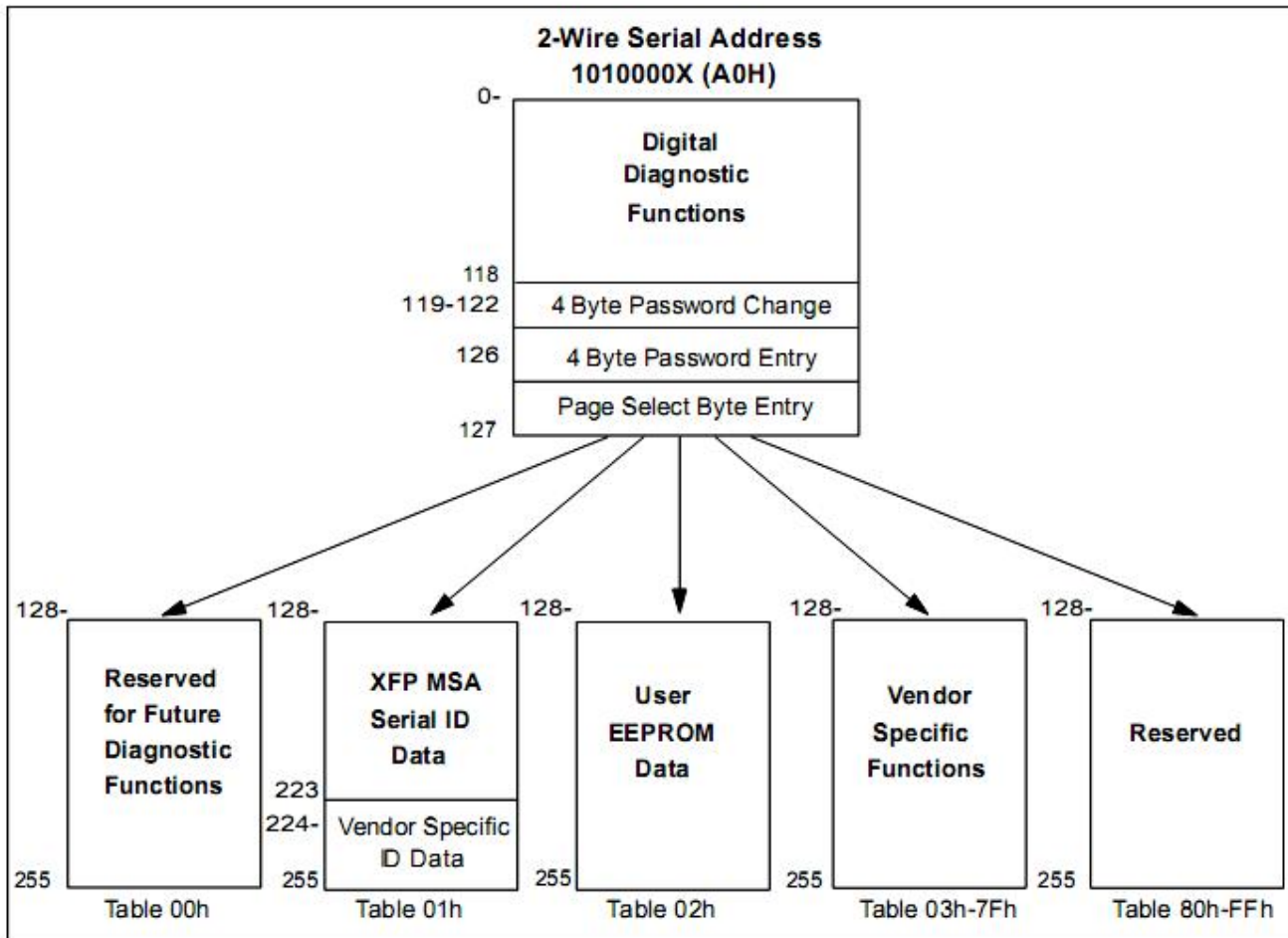

Recommended Host Board Power Supply Circuit

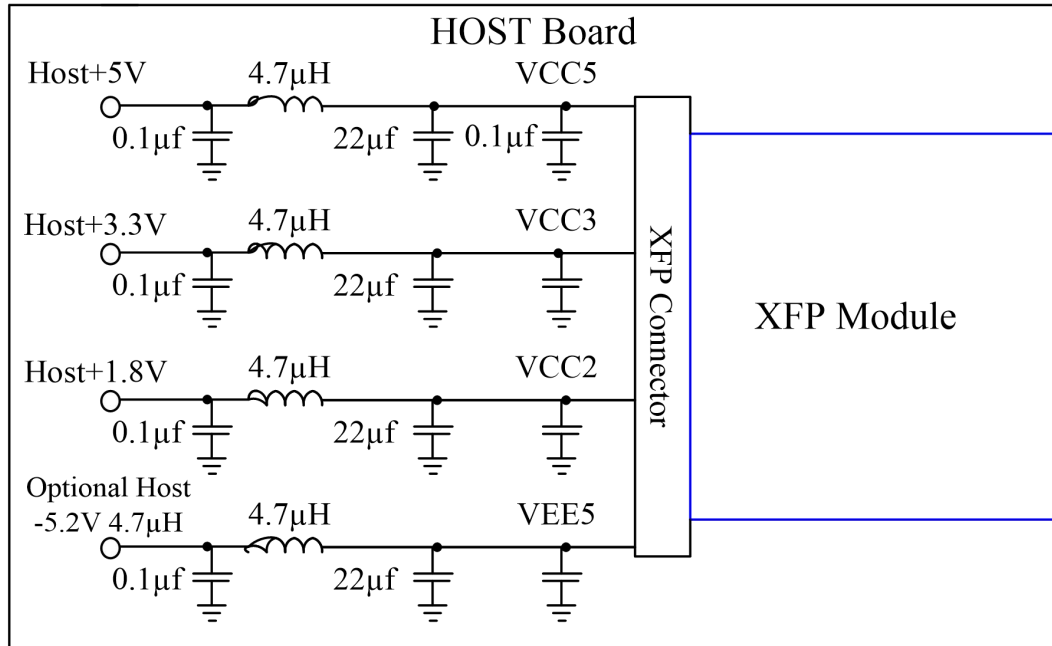

Recommended High-speed Interface Circuit

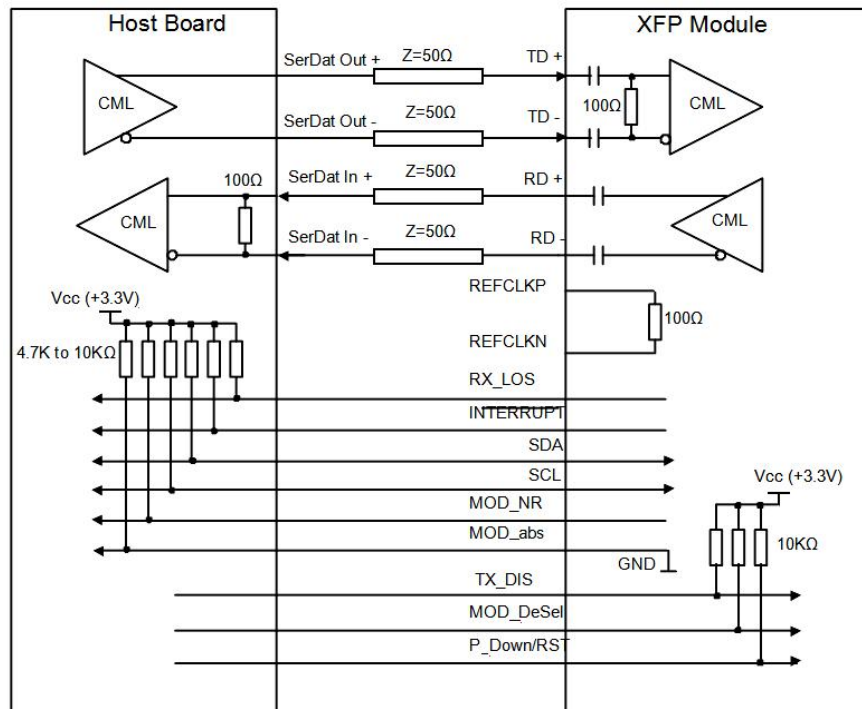

Mechanical Specifications

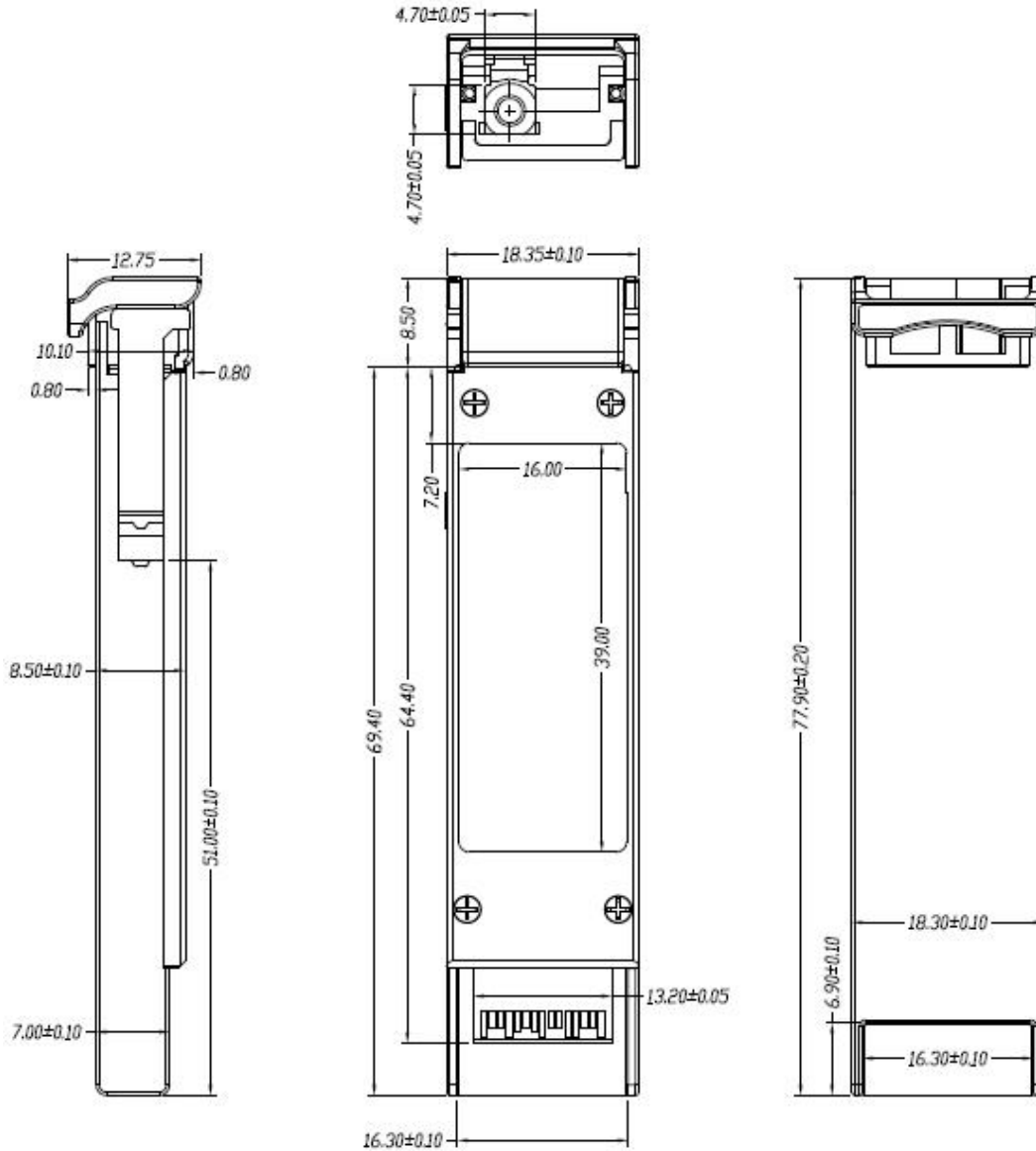

Ordering information

Part Number	Product Description
XFP-BL23TG-10DC	9.953~11.1Gbps, 1270T/1330R, SMF, 10km, 0°C ~ +70°C

For More Information

Tel:+86-755-23301665

E-mail : sales@fibertoptech.com

Web: <http://www.fibertopsfp.com>